

A463-0025-02
PE-21901

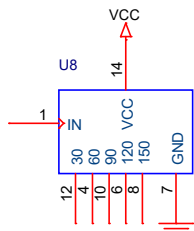

AIDM-150
(pinout is a maybe)

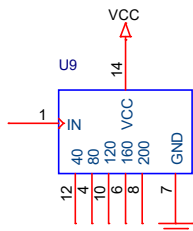

EP8204

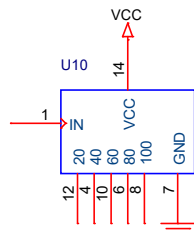

DTZM1-100

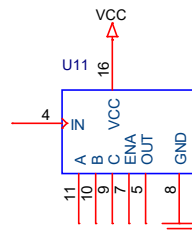

PLDM7-1
3-bit programmanle

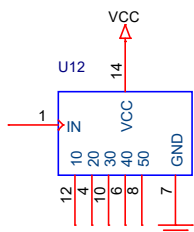
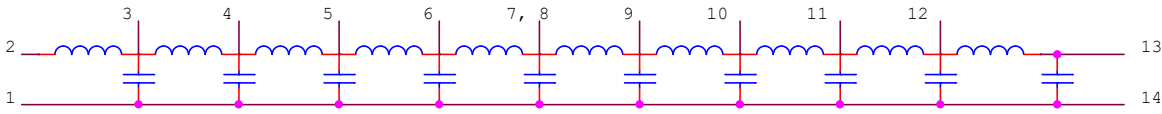

DL14CB500

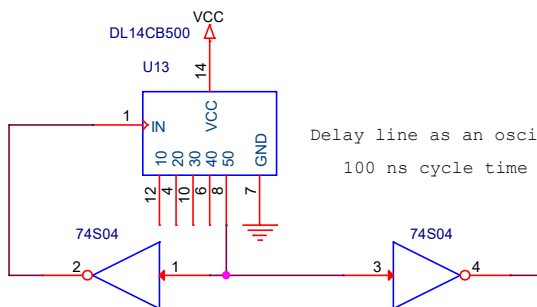

Delay line as an oscillator.
100 ns cycle time

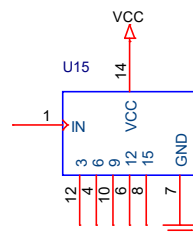

FSTD1-015

Title		
Delay lines		
Size	Document Number	Rev
A	Design 1901	1
Date:	Tuesday, July 27, 2021	Sheet 2 of 2