

# SCB2677

## Video Attributes Controller (VAC)

### Product Specification

#### Microprocessor Products

#### DESCRIPTION

The Signetics SCB2677A and SCB-2677B Video Attributes Controllers (VAC) are bipolar LSI devices designed for CRT terminals and display systems that employ raster scan techniques. Each contains a high-speed video shift register, field and character attributes logic, attribute latch, cursor format logic and half-dot shift control.

The VAC provides control of visual attributes on a field or character-by-character. Internal logic preserves field attribute data from character row to character row so that an attribute byte is not required at the beginning of each row. The SCB2677B provides for reverse video, blank (non-display), blink, underline and highlight attributes and a graphics mode attribute to work in conjunction with the Signetics SCN2670 Display Character and Graphics Generators (DCGG). The SCB2677A substitutes a strike-through attribute for the graphics attribute.

The horizontal dot frequency is the basic timing input to the VAC. Internally, this clock is divided down to provide a character clock output for system synchronization. Up to ten bits of video dot data are parallel-loaded into the video shift register on each character boundary. The video data is encoded to three levels of intensity (black, gray and white) and output on two TTL outputs. Light or dark screen background may be specified.

#### FEATURES

- 18MHz and 25MHz video dot rates
- Three level-encoded TTL video outputs
- Character/field attribute logic
  - Reverse video
  - Character blank
  - Character blink
  - Underline
  - Highlight
- Strike-through or graphics control
- Field attributes extend from row to row
- Light or dark field
- Cursor reverse video logic
- Up to 12 dots per character
- Retrace blanking for light field
- Optional field graphics control output
- High-speed bipolar design
- TTL compatible
- Compatible with Signetics SCN2672 PVTC, SCN2674 AVDC and SCN2670 DCGG
- Upgrade of the Signetics SCB2673 VAC

#### APPLICATIONS

- CRT terminals
- Word processing systems
- Small business computers

#### PIN CONFIGURATIONS

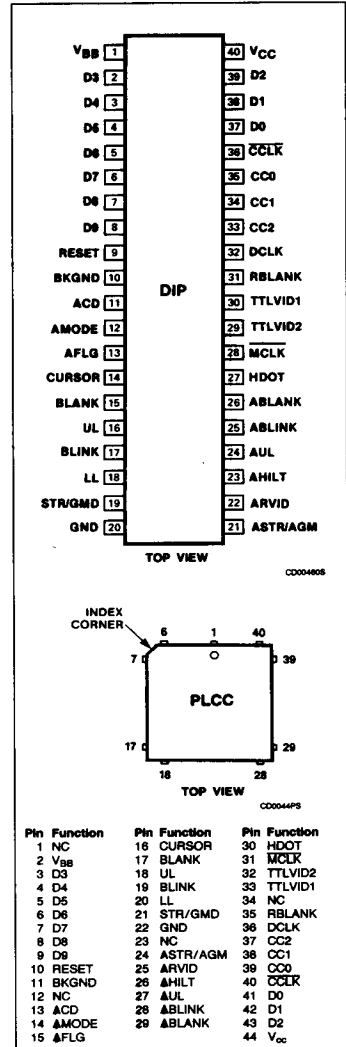

# Video Attributes Controller (VAC)

SCB2677

## ORDERING INFORMATION

PACKAGES	$V_{CC} = +5V \pm 5\%$ , $T_A = 0^\circ C$ to $+70^\circ C$			
	Graphics Attribute		Strike-Through Attribute	
	25MHz	18MHz	25MHz	18MHz
Ceramic DIP	SCB2677BC5I40	SCB2677BC8I40	SCB2677AC5I40	SCB2677AC8I40
Plastic DIP	SCB2677BC5N40	SCB2677BC8N40	SCB2677AC5N40	SCB2677AC8N40
Plastic LCC	SCB2677BC5A44	SCB2677BC8A44	SCB2677AC5A44	SCB2677AC8A44

## BLOCK DIAGRAM

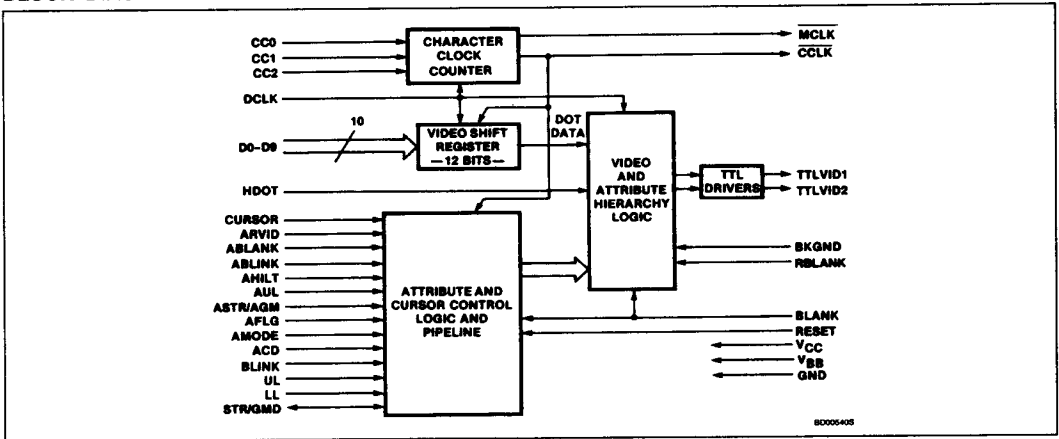

## Video Attributes Controller (VAC)

SCB2677

## PIN DESCRIPTION

MNEMONIC	PIN NO.		TYPE	NAME AND FUNCTION
	DIP	PLCC		
DCLK	32	36	I	<b>Dot Clock:</b> Dot frequency input. Video output shift rate.
CCCLK	36	40	O	<b>Character Clock:</b> A submultiple of DCLK. The frequency ranges from one sixth to one twelfth of DCLK, as determined by the state of the CC0-CC2 inputs.
CC2 - CC0	33 - 35	37 - 39	I	<b>Character Clock Control:</b> The logic state on these three static inputs determine the internal divide factor for the CCCLK output rate. Character clock rates of 6 through 12 dots per character may be specified.
D0 - D9	37 - 39, 2 - 8	41 - 43, 3 - 9	I	<b>Dot Data Input:</b> These are parallel inputs corresponding to the character/graphic symbol dot data for a given scan line. These inputs are strobed into the video shift register on the falling edge of each character clock.
HDOT	27	30	I	<b>Half-Dot Shift:</b> When this input is high, the serial video output is delayed by one-half dot time. This input is latched on the falling edge of each character clock.
CURSOR	14	16	I	<b>Cursor Timing:</b> This input provides the timing for the cursor video. When high, effectively reverses the intensities of the video and attributes. Cursor position, shape, and blink rate are controlled by this input.
BKGND	10	11	I	<b>Background Intensity:</b> Specifies light or dark video during BLANK and character fields. Affects the intensities of all attributes.
BLANK	15	17	I	<b>Screen Blank:</b> When high, this input forces the video outputs to the level specified by the BKGND input (either high or low intensity). Not effective when RBLANK is high.
RBLANK	31	35	I	<b>Retrace Blank:</b> This input is used to force the two video outputs to a low intensity (black) during retrace intervals. If held high (1), it will automatically suppress video when BLANK is high (1). The user may pulse this input while BLANK is high to selectively suppress raster video.
ARVID	22	25	I	<b>Reverse Video Attribute:</b> The intensity of the associated character or field video is reversed. All other attributes are effectively reversed.
AHILT	23	26	I	<b>Highlight Attribute:</b> All-dot video (including underline) of the associated character or field is highlighted with respect to the BKGND input and the reverse video attribute.
ABLANK	26	29	I	<b>Blank Attribute:</b> Generates a blank space in the associated character or field. The blank space intensity is determined by the BKGND input, the reverse video attribute, and the CURSOR input.
ABLINK	25	28	I	<b>Blink Attribute:</b> The associated character or field video is driven to the intensity determined by BKGND and the reverse video attribute when the BLINK input is high.
AUL	24	27	I	<b>Underline Attribute:</b> Specifies a line to be displayed on the character or field. The line is specified by the UL input. All other attributes apply to the underline video.
ASTR/AGM	21	24	I	<b>Strike-Through Attribute (2677A):</b> Specifies a line to be displayed on the character or field. The line is specified by the STR input. <b>Attribute Graphics Mode (2677B):</b> This input is latched and synchronized to provide a field GMD output for the SCN2670 DCGG.
AMODE	12	14	I	<b>Attribute Mode:</b> Specifies character (AMODE = 0) or field (AMODE = 1) attribute mode.
AFLG	13	15	I	<b>Attributes Flag:</b> The VAC samples and latches the attributes inputs when this input is high. If field attributes are specified (AMODE = 1), the attributes are double buffered on a row basis. Thus, each scan line of every character row will start with the attributes that were valid at the end of the previous row.
ACD	11	13	I	<b>Attribute Control Display:</b> In field attributes mode (AMODE = 1), if ACD = 0, the first character in each new attribute field (the attribute control character) will be suppressed and only the attributes will be displayed. If ACD = 1, the first character and the attributes are displayed. This input has no effect in character mode (AMODE = 0).
BLINK	17	19	I	<b>Blink:</b> This input is sampled on the falling edge of the BLANK to provide the blink rate for the character blink attribute. It should be a submultiple of the frame rate.
UL	16	18	I	<b>Underline:</b> Indicates the scan line(s) for the underline attribute. Latched on the falling edge of BLANK.

## Video Attributes Controller (VAC)

SCB2677

## PIN DESCRIPTION (Continued)

MNEMONIC	PIN NO.		TYPE	NAME AND FUNCTION
	DIP	PLCC		
STR/GMD	19	21	I O	<b>Strike-Through Line (2677A):</b> Indicates the scan line(s) for the strike-through attribute. Latched on the falling edge of BLANK. <b>Graphics Mode (2677B):</b> This output provides a synchronized, latched, field graphics mode corresponding to the AGM input. This output can be used to control the GM input on the SCN2670 DCGG.
LL	18	20	I	<b>Last Line:</b> Indicates the last scan line of each character row. Used internally to extend field attributes across row boundaries. Latched on the falling edge of BLANK. This input has no effect in character mode (AMODE = 0).
MCLK	28	31	O	<b>Memory Clock:</b> This output is active for the last dot time for each CCLK period. See Figure 1.
TTLVID1	30	33	O	<b>TTL Video 1:</b> This output corresponds to the serial, non-highlighted video dot pattern.
TTLVID2	29	32	O	<b>TTL Video 2:</b> This output corresponds to the highlighted serial video dot pattern. Should be used with TTLVID1 to decode a composite video of three intensities.
RESET	9	10	I	<b>Manual Reset:</b> This active high input initializes the internal logic and resets the attribute latches.
V <sub>CC</sub>	40	44	I	<b>Power Supply:</b> +5V.
V <sub>BB</sub>	1	2	I	<b>Bias Supply:</b> See Figure 14.
GND	20	22	I	<b>Ground:</b> 0V reference.

## FUNCTIONAL DESCRIPTION

The VAC consists of four major sections (see block diagram). The high-speed dot clock input is divided internally to provide a character clock for system timing. The parallel dot data is loaded into the video shift register on each character boundary and shifted into the video logic block at the dot rate. The six attribute inputs are latched internally and combined with the serial dot data to provide a three level video source for the monitor.

A separate BLANK input defines the active screen area. When BLANK = 0, the video levels are derived internally by the combinations of dot data, attributes, cursor, and the state of the BKGND input. Either black, gray or white background can be selected. Symbols (dot data) are normally gray and can be highlighted to white or black as shown in Figure 2.

During the inactive screen area (BLANK = 1), the video level produced by the TTL outputs is either gray (BKGND = 1) or black (BKGND = 0). A separate retrace blank (RBLANK) input is provided to suppress raster retrace video when gray background is specified. This input will force the video outputs to a low if RBLANK and BLANK = 1. The user may pulse RBLANK during the retrace interval in order to extend the gray border closer to the monitor edges.

## Character Clock Counter

The character clock counter divides the frequency on the DCLK input to generate the character clock (CCLK). The divide factor is specified by the clock control inputs

December 12, 1986

CC2	CC1	CC0	CCLK	
			Dots/Character	Duty Cycle*
0	0	0	6	3/3
0	0	1	6	3/3
0	1	0	7	4/3
0	1	1	8	4/4
1	0	0	9	5/4
1	0	1	10	5/5
1	1	0	11	6/5
1	1	1	12	6/6

## NOTE:

\*Low/high

(CC0 - CC2) as shown in the table above. See Figure 1.

## Video Shift Register

On each character boundary, the parallel data (D0 - D9) is loaded into the video shift register. The data is shifted out least significant bit first (D0) by the DCLK. If 11 or 12 dots/character are specified (CC2 - CC0 = 110 or 111), a 0 (blank dot) is always shifted out before D0. For 12 dots/character, a 0 is also shifted out after D9. The serial dot data is shifted into the video logic where it is combined with the cursor and attributes to encode three levels of video.

## Attribute And Cursor Control

The VAC visual attributes capabilities include: reverse video, character blank, blink, underline, highlight, and strike-through. The six attributes and the three attribute control inputs (AMODE, AFLG, and ACD) are clocked into the VAC on the falling edge of CCLK. If AFLG is high, the attributes are latched inter-

nally and are effective for either one character time (AMODE = 0) or until another set of attributes is latched (AMODE = 1). The attributes set is double-buffered on a row-by-row basis internally. Using this technique, field attributes can extend across character row boundaries thereby eliminating the necessity of starting each row with an attribute set.

When field attribute mode is selected, (AMODE = 1), the VAC will accommodate two attribute storage configurations. In one configuration, the attribute control data is stored in the refresh RAM, taking the place of the first character code in the field to be affected. For this mode, the ACD input is tied low and blank characters will be displayed in the screen positions occupied by the attribute data (see Figure 12). The display RAM contains intermixed character and attribute data. When new attribute data is written to the SCB2677, the AFLG input is set high. The character at that location will be blanked, and

# Video Attributes Controller (VAC)

SCB2677

only the attribute information will be displayed. That particular attribute data will be used for the resultant characters until the next AFLG pulse occurs. In the second configuration (ACD = 1), the character codes and attribute data are presented to the VAC in parallel (i.e., there are separate RAMs for the character and attribute data). In this mode, dot data is displayed at each character position (see Figure 13).

The CURSOR and the attribute input signals are pipelined internally to allow for system propagations (one CCLK for refresh RAM, one CCLK for dot generator). The attribute timing signals BLINK, UL, STR and LL are clocked into the VAC at the beginning of each scan line by the falling edge of the BLANK input. Thus, these signals must be in their proper state at the falling edge of BLANK preceding the scan line at which they are to be active (see Figure 5). The SCN2670 DCGG delays the character dot data by one character clock. The VAC assumes that there is a DCGG in the system and latches the dot data one character clock later than the latching of the attribute data.

### Video Logic

The serial dot data and the pipelined cursor and attributes are combined to generate three levels (white, gray, and black) on two TTL compatible outputs, TTLVID1 and TTLVID2. The three levels are encoded as shown to the right.

The video is normally shifted out on the leading edge of the DCLK. When the HDOT input is asserted, the corresponding dot data is delayed by one-half DCLK. This half dot shifting, when used on selected lines of

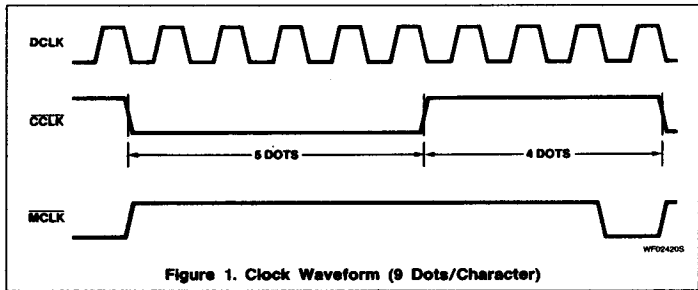

Figure 1. Clock Waveform (9 Dots/Character)

TTLVID2	TTLVID1	INTENSITY
0	0	Black
0	1	Gray
1	0	Not used
1	1	White

**NOTE:**

The TTLVID1 output can be used independently to generate a two-level non-highlighted video.

character video, can be used to effect eye-pleasing character rounding as shown in Figure 3. The half-dot shift does not extend into the next character's field boundary.

### Attribute Hierarchy

The video of each character block consists of four components as shown in Figure 4.

Symbol video is generated from the dot data inputs D0 - D9.

Underline video is enabled by the AUL attribute and is generated when the UL timing input is active. Underline and symbol video are always the same intensity.

Strike-through video is enabled by the ASTR attribute and is generated when the STR timing input is active. This video is the same intensity as the symbol and underline video. This feature applies to the SCB2677A only.

Surround video is the absence of symbol, underline and strike-through video or the presence of the non-display attributes (ABLANK or ABLINK + BLINK).

The relative intensities of the four video components are determined by the remaining attributes (AHILT, ABLANK, ABLINK, ARVID) and the BKGND and CURSOR inputs as illustrated in Table 1.

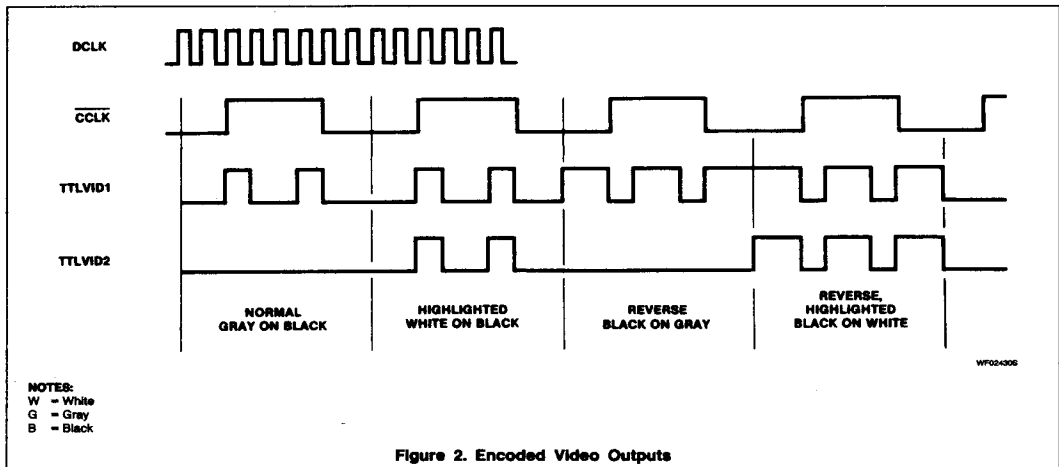

Figure 2. Encoded Video Outputs

# Video Attributes Controller (VAC)

SCB2677

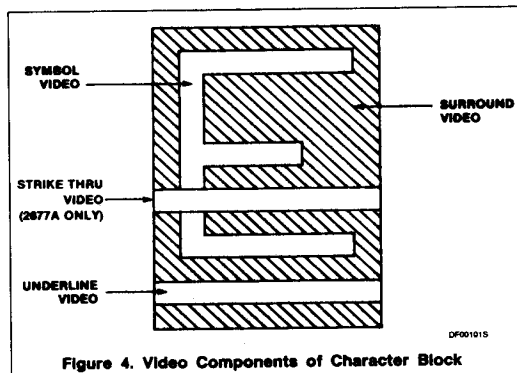
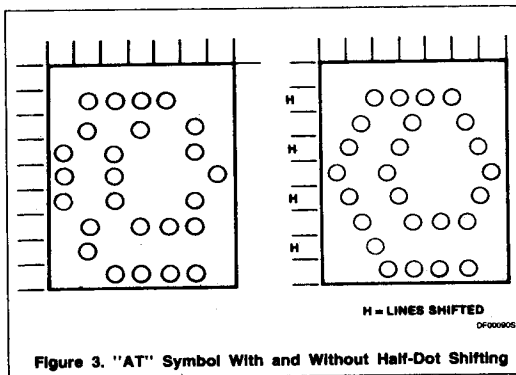

Table 1. Attributes Hierarchy

BLANK	RBLANK	BKGND	REVERSE <sup>1</sup>	AHILT	"NON-" DISPLAY <sup>2</sup>	SYMBOL, UNDERLINE OR STRIKE- THROUGH <sup>3, 4</sup>	SURROUND VIDEO <sup>3</sup>
0	d	0	0	0	0	G	B
0	d	0	0	0	1	B	B
0	d	0	0	1	0	W	B
0	d	0	0	1	1	B	B
0	d	0	1	0	0	B	G
0	d	0	1	0	1	G	G
0	d	0	1	1	0	B	W
0	d	0	1	1	1	W	W
0	d	1	0	0	0	B	G
0	d	1	0	0	1	G	G
0	d	1	0	1	0	B	W
0	d	1	0	1	1	W	W
0	d	1	1	0	0	G	B
0	d	1	1	0	1	B	B
0	d	1	1	1	0	W	B
0	d	1	1	1	1	B	B
1	0	0	d	d	d	B	B
1	0	1	d	d	d	G	G
1	1	d	d	d	d	B	B

**NOTES:**

B = Black

G = Gray

W = White

d = Don't care

1. REVERSE = ARVID ⊕ CURSOR

2. Non-display = (ABLANK ⊕ BLINK) + ABLANK

3. See Figure 4.

4. Symbol, underline and strike-through are always same intensity.

## Video Attributes Controller (VAC)

SCB2677

ABSOLUTE MAXIMUM RATINGS<sup>1</sup>

SYMBOL	PARAMETER	RATING	UNIT
T <sub>A</sub>	Operating ambient temperature <sup>2</sup> range	0 to +70	°C
T <sub>STG</sub>	Storage temperature range	-65 to +150	°C
	All voltages with respect to ground	-0.5 to +6.0	V

DC ELECTRICAL CHARACTERISTICS T<sub>A</sub> = 0°C to +70°C, V<sub>CC</sub> = +5V ± 5%, V<sub>BB</sub> = See Figure 14<sup>3, 4, 5, 6</sup>

SYMBOL	PARAMETER	TEST CONDITIONS	LIMITS			UNIT
			Min	Typ	Max	
V <sub>IL</sub> V <sub>IH</sub>	Input low voltage Input high voltage		2		0.8	V V
V <sub>OL</sub> V <sub>OH</sub>	Output low voltage Output high voltage	I <sub>OL</sub> = 4mA I <sub>OH</sub> = -400μA	2.4		0.4	V V
I <sub>IL</sub> I <sub>IH</sub>	Input low current Input high current	V <sub>IN</sub> = 0.4V V <sub>IN</sub> = 2.4V			-400/ -800 <sup>6</sup> 20/40 <sup>6</sup>	μA μA
I <sub>CC</sub> I <sub>BB</sub>	V <sub>CC</sub> supply current V <sub>BB</sub> supply current	V <sub>IN</sub> = 0V, V <sub>CC</sub> = Max V <sub>BB</sub> = Max			80 120	mA mA

## NOTES:

- Stresses above those listed under Absolute Maximum Ratings may cause permanent damage to the device. This is a stress rating only and functional operation of the device at these or at any other condition above those indicated in the operation section of this specification is not implied.
- Operating at elevated temperatures, the device must be derated based on +150°C maximum junction temperature.
- Parameters are valid over operating temperature range unless otherwise specified.
- All voltage measurements are referenced to ground (V<sub>SS</sub>). All input signals swing between 0.4V and 2.4V. All time measurements are referenced at input voltages of 0.8V, 2V and at output voltage of 0.8V, 2V as appropriate.
- Typical values are at +25°C, typical supply voltages and typical processing parameters.
- For DCLK input.
- C<sub>L</sub> less than 150pF minimum could be faster.

## Video Attributes Controller (VAC)

SCB2677

**AC ELECTRICAL CHARACTERISTICS**  $T_A = 0^\circ\text{C}$  to  $+70^\circ\text{C}$ ,  $V_{CC} = +5\text{V} \pm 5\%$ ,  $V_{BB} =$  See Figure 14<sup>3</sup>, 4, 5, 6

SYMBOL	PARAMETER	TEST CONDITIONS	LIMITS				UNIT
			25MHz Version		18MHz Version		
			Min	Max	Min	Max	
<b>Dot clock (Figure 11)</b>							
$t_D$	Frequency			25		18	MHz
$t_{DH}$	High		15		22		ns
$t_{DL}$	Low		15		22		ns
<b>Setup times to <math>\overline{\text{CCLK}}</math> (Figures 5, 6, 7 and 11)</b>							
$t_{BS}$	BLANK		50		50		ns
$t_{SC}$	BLINK, UL, STR, LL (ref to BLANK)		20		20		ns
$t_{SA}$	Attributes		45		55		ns
$t_{SD}$	Dot data D0 - D9		70		70		ns
$t_{SK}$	CURSOR		50		50		ns
$t_{FS}$	AFLG		50		65		ns
$t_{SH}$	HDOT		45		55		ns
<b>Hold times from <math>\overline{\text{CCLK}}</math> (Figures 5, 6, 7 and 11)</b>							
$t_{HC}$	BLINK, UL, STR, LL (ref to BLANK)		20		20		ns
$t_{HA}$	Attributes		20		20		ns
$t_{HD}$	Dot data D0 - D9		30		30		ns
$t_{HK}$	CURSOR		20		20		ns
$t_{FH}$	AFLG		30		30		ns
$t_{HH}$	HDOT		20		20		ns
<b>Setup times to DCLK (Figures 9,10)</b>							
$t_{SG}$	BKGND		15		15		ns
$t_{SB}$	RBLANK		15		15		ns
$t_{CS}$	CC0 - CC2		30		35		ns
<b>Hold times from DCLK (Figures 9,10)</b>							
$t_{HG}$	BKGND		15		15		ns
$t_{HB}$	RBLANK		15		15		ns
$t_{CH}$	CC0 - CC2		20		20		ns
<b>Delay times (Figures 7 and 8)</b>							
$t_{DGM}$	GMD from DCLK			65		65	ns
$t_{DC}$	MCLK, $\overline{\text{CCLK}}$ from DCLK	$C_L = 150\text{pF}$		65		65	ns
$t_{DV7}$	TTLVID1 and TTLVID2 from DCLK			75		80	ns



Video Attributes Controller (VAC)

SCB2677

2

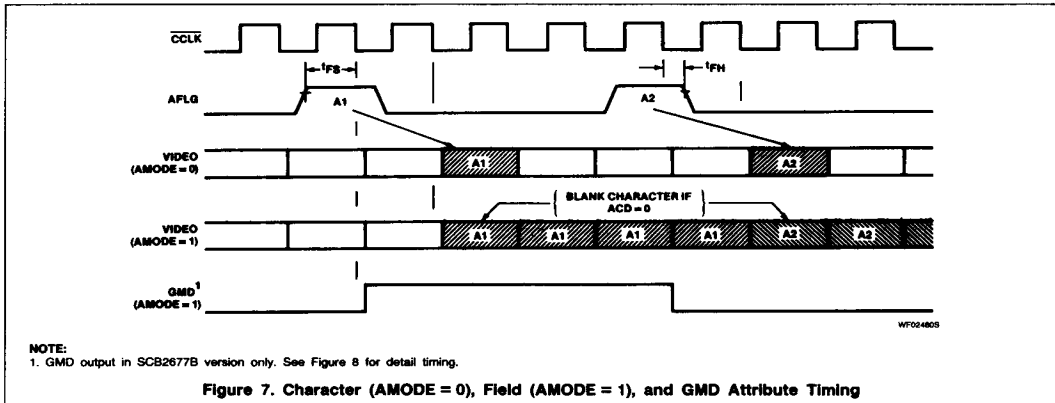
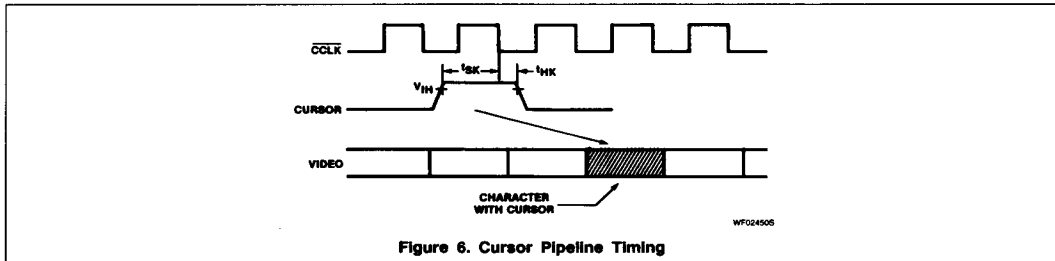
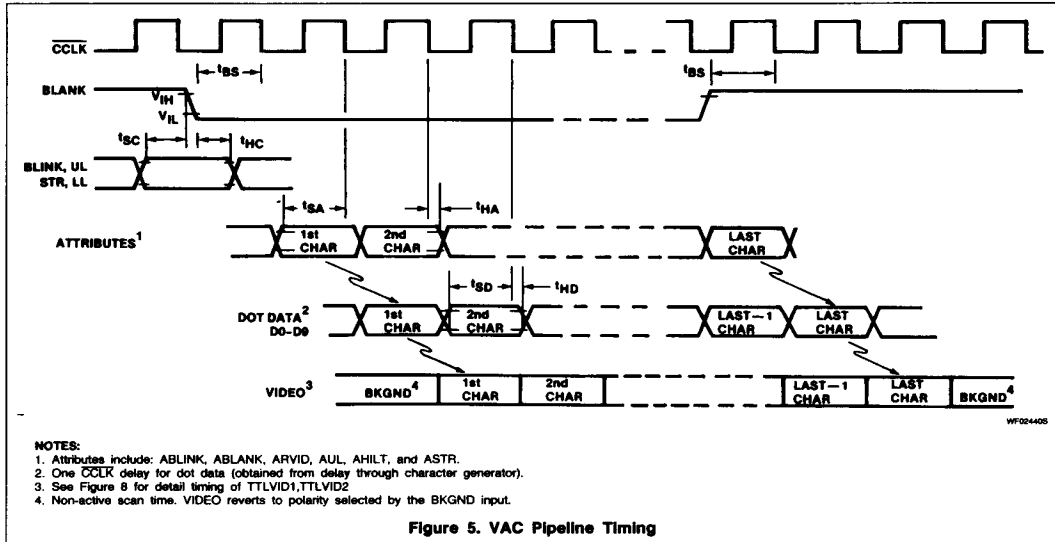

Video Attributes Controller (VAC)

SCB2677

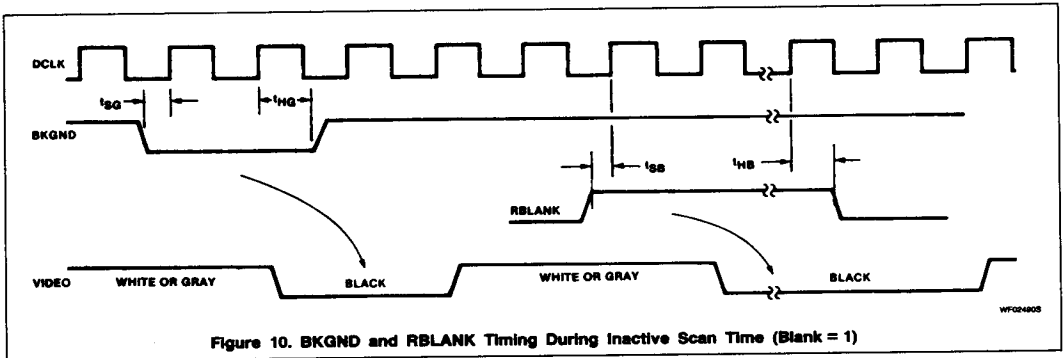
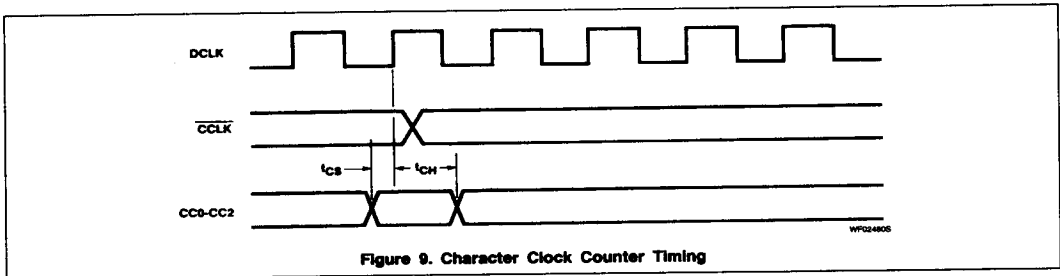
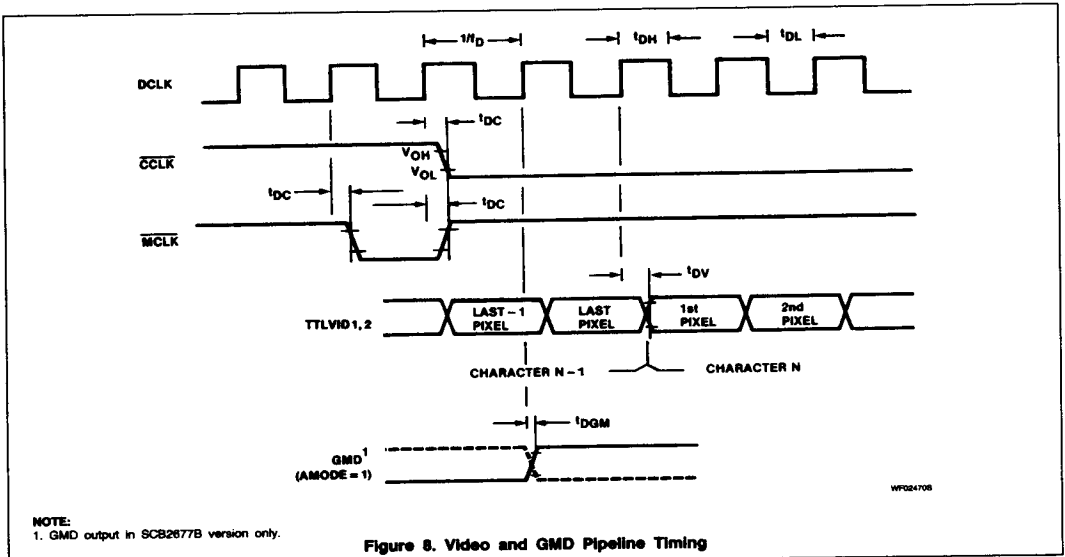

# Video Attributes Controller (VAC)

SCB2677

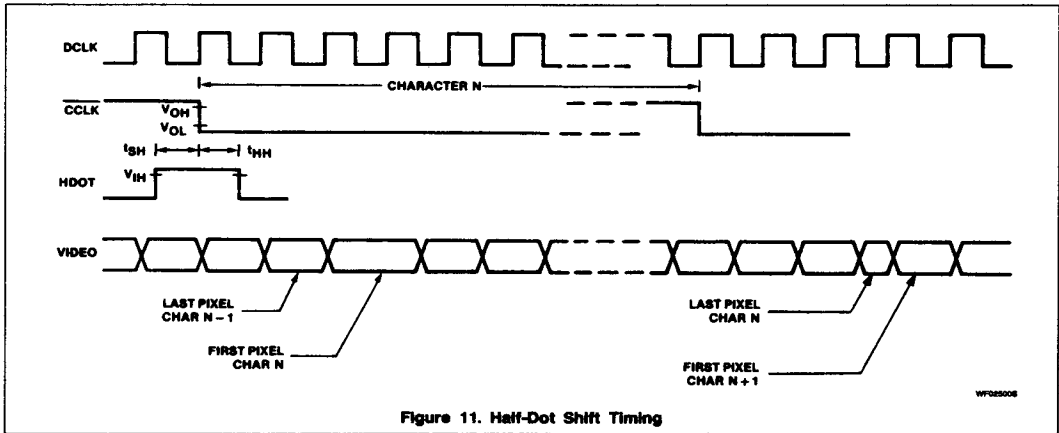

Figure 11. Half-Dot Shift Timing

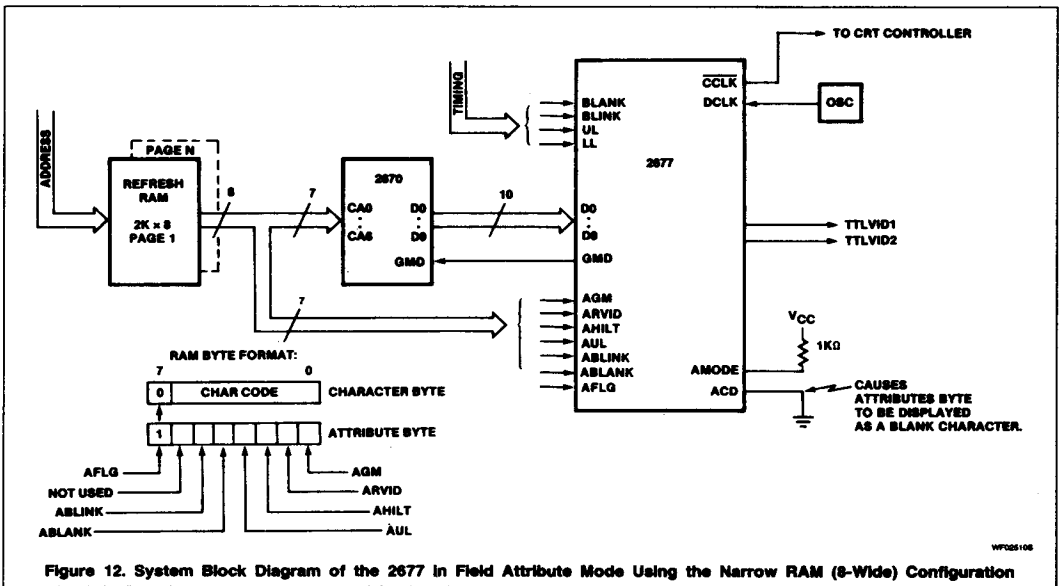

Figure 12. System Block Diagram of the 2677 in Field Attributes Mode Using the Narrow RAM (8-Wide) Configuration

# Video Attributes Controller (VAC)

## SCB2677

